

SPECIFICATION FOR LCD MODULE

Model No. TM128160CKFWG

Prepared by:	Date:
Checked by :	Date:
Verified by :	Date:
Approved by:	Date:

TIANMA MICROELECTRONICS CO., LTD

REVISION RECORD

Date	Ver.	Ref. Page	Revision No.	Revision Items

1. General Specifications:

- 1.1 Display type: COLOR STN
- 1.2 Display color*¹:
 - Display color: 65K COLOR
 - Background*²: Black (Red, Green, Blue dots are off state)
- 1.3 Polarizer mode: Transmissive/Negative
- 1.4 Viewing Angle: 6:00
- 1.5 Driving Method: 1/160 Duty 1/10 Bias
- 1.6 Backlight Type: LED (3 LAMPS)
 - Backlight Color: WHITE
- 1.7 Controller: HCD667A66
- 1.8 Data Transfer: 8 Bit Parallel
- 1.9 Operating Temperature: -20----+70
 - Storage Temperature: -30----+80
- 1.10 Power Supply Voltage: VDD=3.0V
- 1.11 LCD Operating Voltage: VLCD=16.8V
- 1.12 Outline Dimensions: Refer to outline drawing on next page
- 1.13 Dot Matrix: 128 X 3 (RGB) X 160 Dots
- 1.14 Dot Size: 0.221(R+G+B) × 0.221(mm²)
- 1.15 Dot Pitch: 0.231 × 0.231 (mm²)
- 1.16 Weight: TBD*³

*¹ Color tone is slightly changed by temperature and driving voltage.

*² Color tone will be changed by backlight.

*³ TBD: To Be Determined.

3. LCD Module Part Numbering System

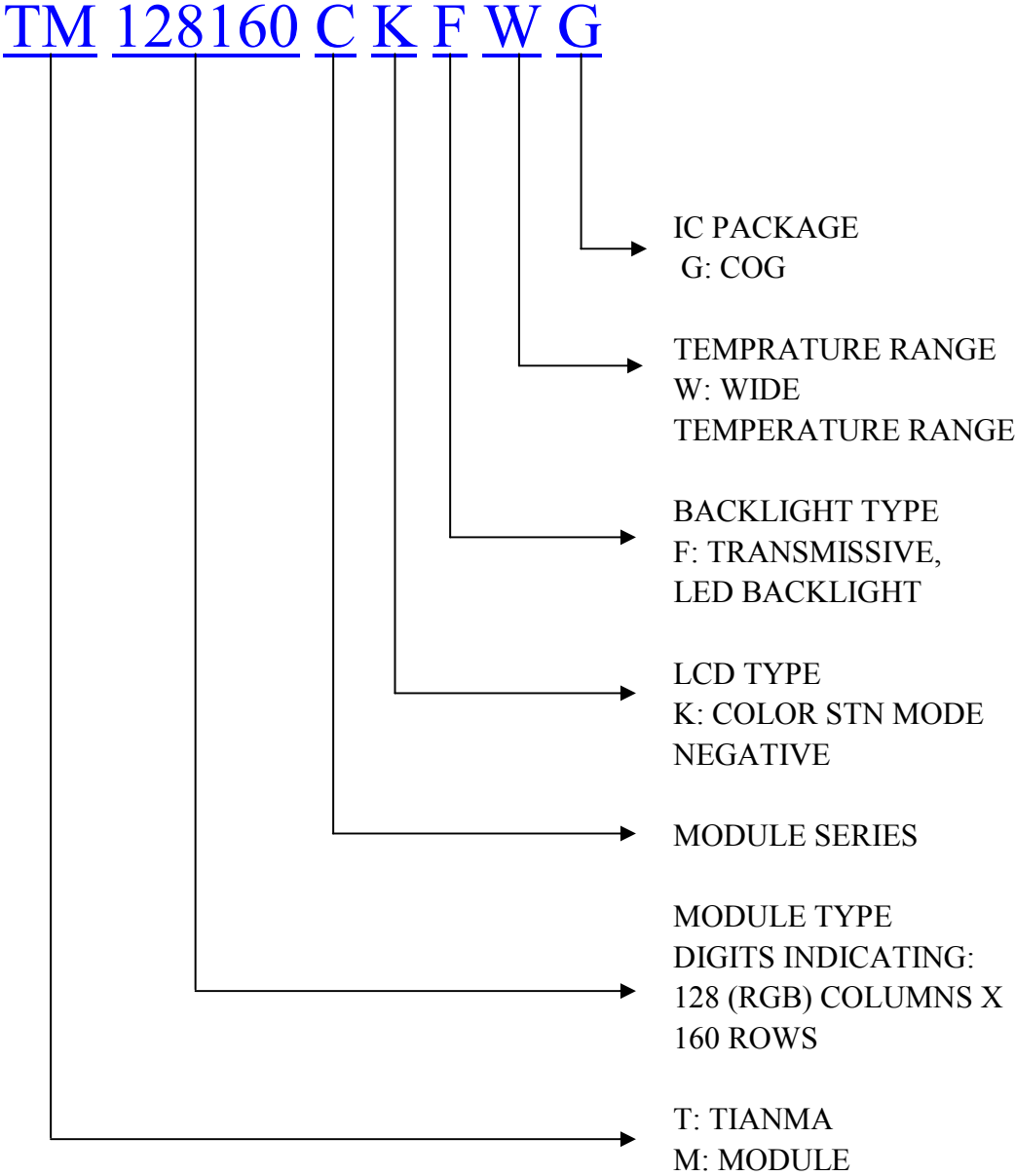

4. Circuit Block Diagram

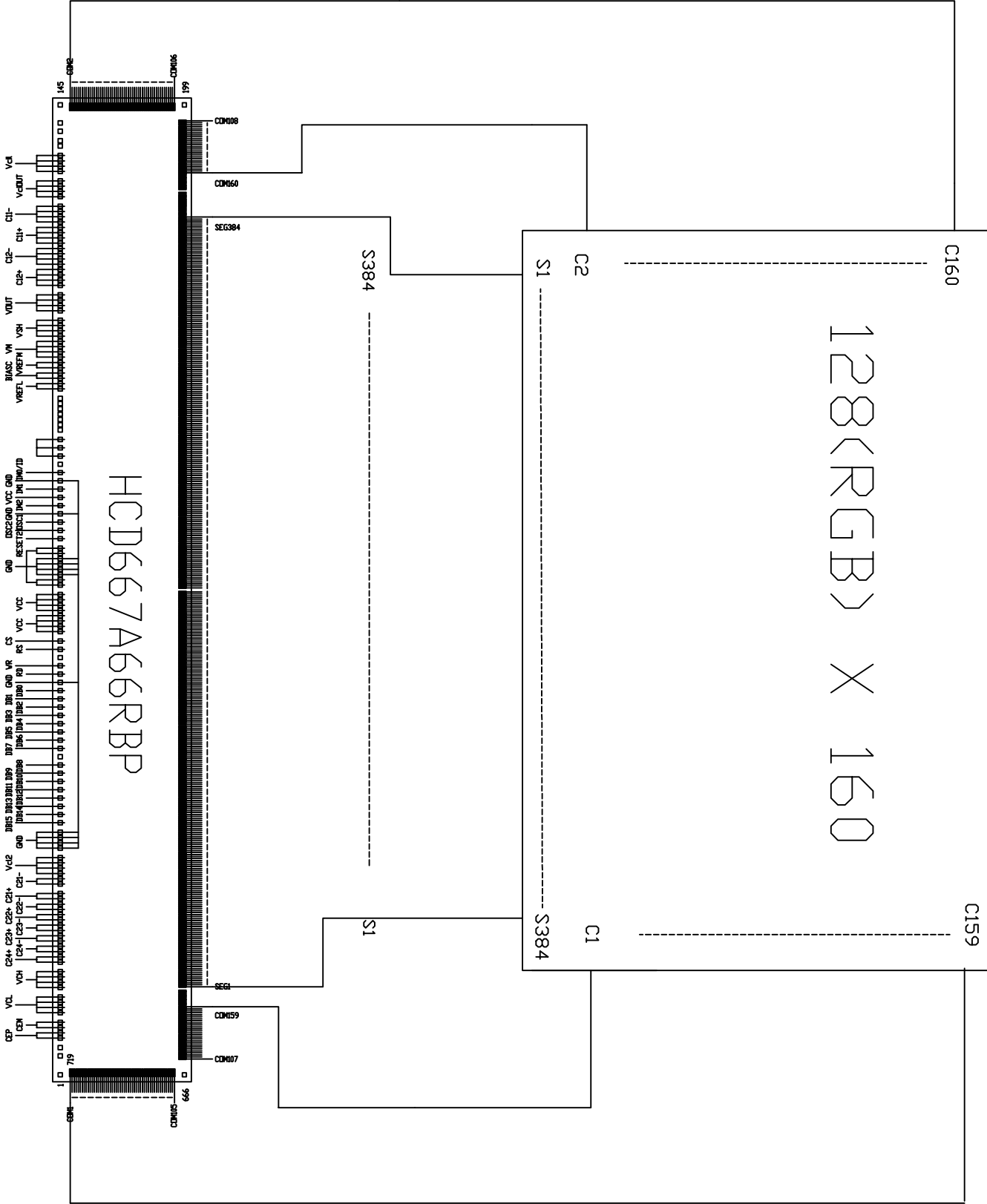

5. Absolute Maximum Ratings

Ta=25

Item	Symbol	Min.	Max.	Unit	Remark
Power Supply Voltage	V _{DD} - V _{SS}	-0.3	+4.6	V	
LCD Driving Voltage	V _{LCD}	-0.3	+20.0		
Operating Temperature Range	T _{OP}	-20	+70		No Condensation
Storage Temperature Range	T _{ST}	-30	+80		

6. Electrical Specifications and Instruction Code

6.1 Electrical characteristics

$V_{SS}=0V$, $T_a=25$

Item	Symbol	Min.	Typ.	Max.	Unit
Supply Voltage (Logic)	$V_{DD}-V_{SS}$	+2.91	+3.0	+3.09	V
Supply Voltage (LCD Drive)	V_{LCD}	-	16.8	-	V
Input Signal Voltage	High V_{IH} ($V_{DD}=3.0$)	$0.8V_{DD}$	-	V_{DD}	V
	Low V_{IL} ($V_{DD}=3.0$)	0	-	$0.2 V_{DD}$	V
Supply current (Logic)	I_{DD} ($V_{DD}-V_{SS}=3.0V$)	-	-	2.5	mA
Operating current	I_{op}	-	-	60	mA
Oscillator frequency range	f_{osc}	220	-	330	KHz
Supply Voltage (LED)	V_{LED}	-	9.9	-	V
Supply current (LED)	I_{LED}		15.0	20.0	mA

6.2 Interface Signals

6.2.1 CN1

Pin No.	Symbol	Level	Description
1	GND	0V	Ground
2	DB7	H/L	Data bus bit 7
3	DB6	H/L	Data bus bit 6
4	DB5	H/L	Data bus bit 5
5	DB4	H/L	Data bus bit 4
6	DB3	H/L	Data bus bit 3
7	DB2	H/L	Data bus bit 2
8	DB1	H/L	Data bus bit 1
9	DB0	H/L	Data bus bit 0
10	RD	H/L	Signal to select data read operation(80-system)
11	WR	H/L	Signal to select data write operation(80-system)
12	RS	H/L	Index register / Data command select
13	CS	H/L	Chip select: Low active
14	VCC	3.0V	Logic circuit power supply
15	VCC	3.0V	Logic circuit power supply
16	GND	0V	Ground
17	GND	0V	Ground
18	RESET	H/L	Reset pin: Low active
19	VCC	3.0V	Logic circuit power supply
20	GND	0V	Ground

6.2.2 CN2

Pin No.	Symbol	Level	Description
1, 2	CATHODE	0V	LED CATHODE
3, 4	ANODE	9.9V	LED ANODE

6.3 Interface Timing Chart

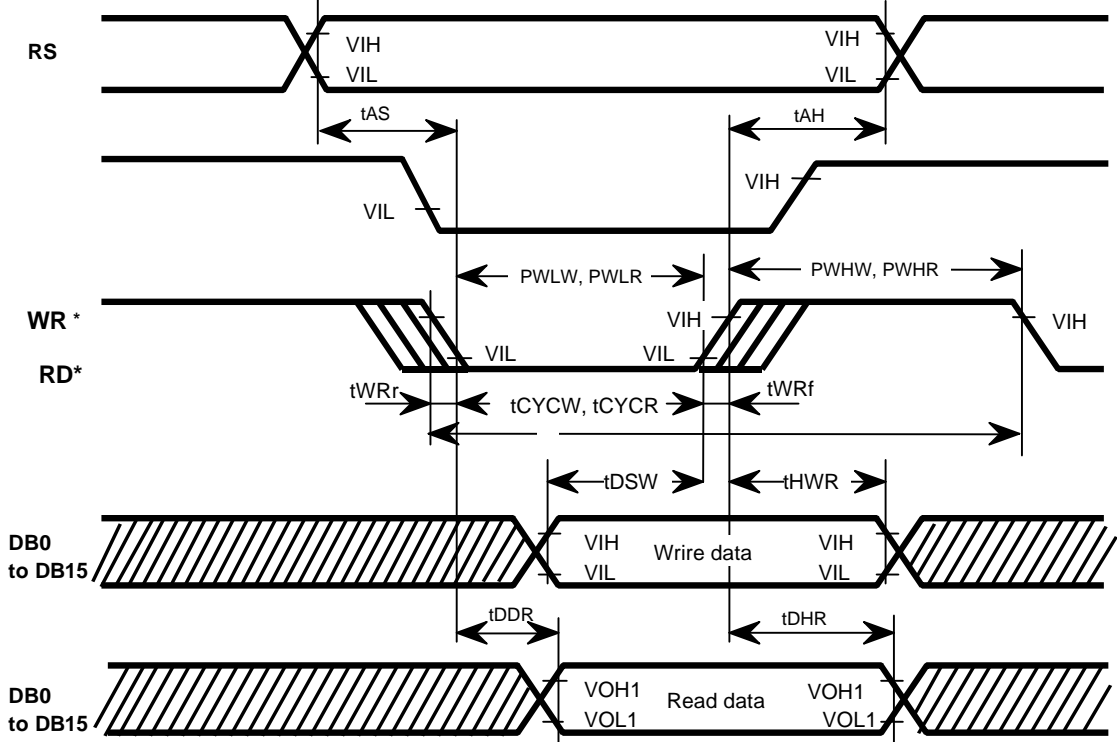

80-system Bus Interface Timing Characteristics

Normal Write Mode (HWM=0) (Vcc = 2.2 to 2.4 V)

Item		Symbol	Unit	Test Condition	Min	Typ	Max
Bus cycle time	Write	t_{CYCW}	ns	Figure 2	600	—	—
	Read	t_{CYCR}	ns	Figure 2	800	—	—
Write low-level pulse width		PW_{LW}	ns	Figure 2	90	—	—
Read low-level pulse width		PW_{LR}	ns	Figure 2	350	—	—
Write high-level pulse width		PW_{HW}	ns	Figure 2	300	—	—
Read high-level pulse width		PW_{HR}	ns	Figure 2	400	—	—
Write/Read rise/fall time		$t_{WRr, WRf}$	ns	Figure 2	—	—	25
Set up time (RS to CS*, WR*, RD*)		t_{AS}	ns	Figure 2	10	—	—
Address hold time		t_{AH}	ns	Figure 2	5	—	—
Write data setup time		t_{DSW}	ns	Figure 2	60	—	—
Write data hold time		t_H	ns	Figure 2	15	—	—
Read data delay time		t_{DDR}	ns	Figure 2	—	—	200
Read data hold time		t_{DHR}	ns	Figure 2	5	—	—

High-Speed Write Mode (HWM=1) (Vcc = 2.2 to 2.4V)

Item		Symbol	Unit	Test Condition	Min	Typ	Max
Bus cycle time	Write	t_{CYCW}	ns	Figure 2	200	—	—
	Read	t_{CYCR}	ns	Figure 2	800	—	—
Write low-level pulse width		PW_{Lw}	ns	Figure 2	90	—	—
Read low-level pulse width		PW_{LR}	ns	Figure 2	350	—	—
Write high -level pulse width		PW_{HW}	ns	Figure 2	90	—	—
Read high -level pulse width		PW_{HR}	ns	Figure 2	400	—	—
Write/Read rise/fall time		$t_{WRr, WRf}$	ns	Figure 2	—	—	—
Set up time (RS to CS*, WR*, RD*)		t_{AS}	ns	Figure 2	10	—	—
Address hold time		t_{AH}	ns	Figure 2	5	—	—
Write data set up time		t_{DSW}	ns	Figure 2	60	—	—
Write data hold time		t_H	ns	Figure 2	15	—	—
Read data delay time		t_{DDR}	ns	Figure 2	—	—	—
Read data hold time		t_{DHR}	ns	Figure 2	5	—	—

Normal Write Mode (HWM=0) (Vcc = 2.4 to 3.6 V)

Table 50

Item		Symbol	Unit	Test Condition	Min	Typ	Max
Bus cycle time	Write	t_{CYCW}	ns	Figure 2	200	—	—
	Read	t_{CYCR}	ns	Figure 2	300	—	—
Write low-level pulse width		PW_{Lw}	ns	Figure 2	40	—	—
Read low-level pulse width		PW_{LR}	ns	Figure 2	150	—	—
Write high -level pulse width		PW_{HW}	ns	Figure 2	100	—	—
Read high -level pulse width		PW_{HR}	ns	Figure 2	100	—	—
Write/Read rise/fall time		t_{WRr}, WRf	ns	Figure 2	—	—	25
Set up time (RS to CS*, WR*, RD*)		t_{AS}	ns	Figure 2	10	—	—
Address hold time		t_{AH}	ns	Figure 2	2	—	—
Write data set up time		t_{DSW}	ns	Figure 2	60	—	—
Write data hold time		t_H	ns	Figure 2	2	—	—
Read data delay time		t_{DDR}	ns	Figure 2	—	—	200
Read data hold time		t_{DHR}	ns	Figure 2	5	—	—

High-Speed Write Mode (HWM=1) (Vcc = 2.4 to 3.6 V)

Item		Symbol	Unit	Test Condition	Min	Typ	Max
Bus cycle time	Write	t_{CYCW}	ns	Figure 2	100	—	—
	Read	t_{CYCR}	ns	Figure 2	300	—	—
Write low-level pulse width		PW_{Lw}	ns	Figure 2	40	—	—
Read low-level pulse width		PW_{LR}	ns	Figure 2	150	—	—
Write high -level pulse width		PW_{HW}	ns	Figure 2	40	—	—
Read high -level pulse width		PW_{HR}	ns	Figure 2	100	—	—
Write/Read rise/fall time		t_{WRr}, WRf	ns	Figure 2	—	—	25
Set up time (RS to CS*, WR*, RD*)		t_{AS}	ns	Figure 2	10	—	—
Address hold time		t_{AH}	ns	Figure 2	2	—	—
Write data set up time		t_{DSW}	ns	Figure 2	60	—	—
Write data hold time		t_H	ns	Figure 2	2	—	—
Read data delay time		t_{DDR}	ns	Figure 2	—	—	100
Read data hold time		t_{DHR}	ns	Figure 2	5	—	—

6.4 Instruction code

Instruction List

Reg. No.	Register Name	R/W	RS	Upper Code								Lower Code								Description	Execution Cycle			
				DB15	DB14	DB13	DB12	DB11	DB10	DB9	DB8	DB7	DB6	DB5	DB4	DB3	DB2	DB1	DB0					
IR	Index	0	0	*	*	*	*	*	*	*	*	*	*	ID6	ID5	ID4	ID3	ID2	ID1	ID0	Sets the index register value.	0	Note1	
SR	Status read	1	0	L7	L6	L5	L4	L3	L2	L1	L0	0	C6	C5	C4	C3	C2	C1	C0	Reads the driving raster-row position (L7-0) and contrast setting (C6-0).	0			
R00h	Start oscillation	0	1	*	*	*	*	*	*	*	*	*	*	*	*	*	*	*	*	*	1	Starts the oscillation mode.	10 ms	Note1
	Device code read	1	1	0	0	0	0	0	1	1	1	0	1	1	0	0	1	1	0	Reads 0766H.	0			
R01h	Driver output control	0	1	0	0	0	0	0	0	CM	SGS	0	0	0	NL4	NL3	NL2	NL1	NL0	Sets the common driver shift direction (CMS), segment driver shift direction (SGS) and driving duty ratio (NL4-0).	0			
R02h	LCD-driving-waveform control	0	1	0	0	0	0	0	RST	B/C	EOR	0	0	NW	NW	NW	NW	NW	NW	0	Sets LCD drive AC waveform (B/C), and EOR output (EOR) or the number of n-raster-rows (NW5-0) at C-pattern AC drive.	0		
R03h	Power control 1	0	1	BS3	BS2	BS1	BS0	BT3	BT2	BT1	BT0	0	DC2	DC1	DC0	AP1	AP0	SLP	STB	Sets the sleep mode (SLP), standby mode (STB), LCD power on (AP1-0), boosting cycle (DC2-0), boosting output multiplying factor (BT2-0), operation of voltage inverting circuit (BT3) and LCD drive bias value (BS3-0).	0			
R04h	Contrast control	0	1	0	0	0	0	0	VR2	VR1	VR0	0	CT6	CT5	CT4	CT3	CT2	CT1	CT0	Sets the regulator adjustment (VR2-0) and contrast adjustment (CT6-0).	0			
R05h	Entry mode	0	1	SPR	0	0	0	0	0	HWM	0	0	0	I/D1	I/D0	AM	LG2	LG1	LG0	Specifies AC counter mode (AM), increment/decrement mode (I/D1-0), high-speed write mode (HWM).	0	Note2		
R06h	Compare Resister	0	1	CP15	CP14	CP13	CP12	CP11	CP10	CP9	CP8	CP7	CP6	CP5	CP4	CP3	CP2	CP1	CP0	Specifies the compare resister (CP15-0).	0			
R07h	Display control	0	1	0	0	0	0	0	VLE2	VLE1	SPT	0	0	0	0	B/W	REV	D1	D0	Specifies display on (D1-0), black-and-white reversed display (REV), pixel on/off mode (ALB), screen division driving (SPT) and vertical scroll.(VLE2-1)	0			
R08h	Frame frequency control	0	1	0	0	0	0	0	0	DIV1	DIV0	0	0	0	0	RTN3	RTN2	RTN1	RTN0	Specifies the line retrace period (RTN3-0) and operating clock frequency division ratio (DIV1-0).	0			
R0Ch	Power control 2	0	1	0	0	0	0	0	0	0	0	0	0	0	0	0	VC2	VC1	VC0	Sets the adjustment factor for the Vci voltage (VC2-0).	0			
R11h	Vertical scroll control	0	1	VL27	VL26	VL25	VL24	VL23	VL22	VL21	VL20	VL17	VL16	VL15	VL14	VL13	VL12	VL11	VL10	Sets the 1 st screen display start raster-row (VL17-10) and 2 nd screen display start raster-row (VL27-20).	0			
R14h	1 st screen driving position	0	1	SE17	SE16	SE15	SE14	SE13	SE12	SE11	SE10	SE17	SE16	SE15	SE14	SE13	SE12	SE11	SE10	Sets the 1 st screen driving start position (SS17-10) and 1 st screen driving end position (SE17-10).	0			
R15h	2 nd screen driving position	0	1	SE27	SE26	SE25	SE24	SE23	SE22	SE21	SE20	SE27	SE26	SE25	SE24	SE23	SE22	SE21	SE20	Sets 2 nd screen driving start position (SS27-20) and 2 nd screen driving end position (SE27-20).	0			
R16h	Horizontal RAM address position	0	1	HEA7	HEA6	HEA5	HEA4	HEA3	HEA2	HEA1	HEA0	HSA7	HSA6	HSA5	HSA4	HSA3	HSA2	HSA1	HSA0	Sets start (HSA7-0) and end (HEA7-0) of the horizontal RAM address range.	0			
R17h	Vertical RAM address position	0	1	VEA7	VEA6	VEA5	VEA4	VEA3	VEA2	VEA1	VEA0	VSA7	VSA6	VSA5	VSA4	VSA3	VSA2	VSA1	VSA0	Sets start (VSA7-0) and end (VEA7-0) of the vertical RAM address range.	0			
R20h	RAM write data mask	0	1	WM15	WM14	WM13	WM12	WM11	WM10	WM9	WM8	WM7	WM6	WM5	WM4	WM3	WM2	WM1	WM0	Specifies write data mask (WM15-0) at RAM write.	0			

Instruction List (cont.)

Reg. No.	Register Name	R/W	RS	Upper Code								Lower Code								Description	Execution Cycle																
				DB 15	DB 14	DB 13	DB 12	DB 11	DB 10	DB 9	DB 8	DB 7	DB 6	DB 5	DB 4	DB 3	DB 2	DB 1	DB 0																		
R21h	RAM address set	0	1																	AD15–8 (upper)															AD6–0 (lower)	Initially set the RAM address to the address counter (AC).	0
R22	RAM data write	0	1																	Write data (upper)														Write data (lower)	Writes data to the RAM.	0	
	RAM data read	1	1																	Read data (upper)														Read data (lower)	Reads data from the RAM.	0	
R30h	Grayscale palette control (1)	0	1	0	0	PK15	PK14	PK13	PK12	PK11	PK10	0	0	PK05	PK04	PK03	PK02	PK01	PK00	Specifies the grayscale palette.	0																
R31h	Grayscale palette control (2)	0	1	0	0	PK35	PK34	PK33	PK32	PK31	PK30	0	0	PK25	PK24	PK23	PK22	PK21	PK20	Specifies the grayscale palette.	0																
R32h	Grayscale palette control (3)	0	1	0	0	PK55	PK54	PK53	PK52	PK51	PK50	0	0	PK45	PK44	PK43	PK42	PK41	PK40	Specifies the grayscale palette.	0																
R33h	Grayscale palette control (4)	0	1	0	0	PK75	PK74	PK73	PK72	PK71	PK70	0	0	PK65	PK64	PK63	PK62	PK61	PK60	Specifies the grayscale palette.	0																
R34h	Grayscale palette control (5)	0	1	0	0	PK95	PK94	PK93	PK92	PK91	PK90	0	0	PK85	PK84	PK83	PK82	PK81	PK80	Specifies the grayscale palette.	0																
R35h	Grayscale palette control (6)	0	1	0	0	PK 115	PK 114	PK 113	PK 112	PK 111	PK 110	0	0	PK 105	PK 104	PK 103	PK 102	PK 101	PK 100	Specifies the grayscale palette.	0																
R36h	Grayscale palette control (7)	0	1	0	0	PK 135	PK 134	PK 133	PK 132	PK 131	PK 130	0	0	PK 125	PK 124	PK 123	PK 122	PK 121	PK 120	Specifies the grayscale palette.	0																
R37h	Grayscale palette control (8)	0	1	0	0	PK 155	PK 154	PK 153	PK 152	PK 151	PK 150	0	0	PK 145	PK 144	PK 143	PK 142	PK 141	PK 140	Specifies the grayscale palette.	0																
R38h	Grayscale palette control (9)	0	1	0	0	PK 175	PK 174	PK 173	PK 172	PK 171	PK 170	0	0	PK 165	PK 164	PK 163	PK 162	PK 161	PK 160	Specifies the grayscale palette.	0																
R39h	Grayscale palette control (10)	0	1	0	0	PK 195	PK 194	PK 193	PK 192	PK 191	PK 190	0	0	PK 185	PK 184	PK 183	PK 182	PK 181	PK 180	Specifies the grayscale palette.	0																
R3Ah	Grayscale palette control (11)	0	1	0	0	PK 215	PK 214	PK 213	PK 212	PK 211	PK 210	0	0	PK 205	PK 204	PK 203	PK 202	PK 201	PK 200	Specifies the grayscale palette.	0																
R3Bh	Grayscale palette control (12)	0	1	0	0	PK 235	PK 234	PK 233	PK 232	PK 231	PK 230	0	0	PK 225	PK 224	PK 223	PK 222	PK 221	PK 220	Specifies the grayscale palette.	0																
R3Ch	Grayscale palette control (13)	0	1	0	0	PK 255	PK 254	PK 253	PK 252	PK 251	PK 250	0	0	PK 245	PK 244	PK 243	PK 242	PK 241	PK 240	Specifies the grayscale palette.	0																
R3Dh	Grayscale palette control (14)	0	1	0	0	PK 275	PK 274	PK 273	PK 272	PK 271	PK 270	0	0	PK 265	PK 264	PK 263	PK 262	PK 261	PK 260	Specifies the grayscale palette.	0																
R3Eh	Grayscale palette control (15)	0	1	0	0	PK 295	PK 294	PK 293	PK 292	PK 291	PK 290	0	0	PK 285	PK 284	PK 283	PK 282	PK 281	PK 280	Specifies the grayscale palette.	0																
R3Fh	Grayscale palette control (16)	0	1	0	0	PK 315	PK 314	PK 313	PK 312	PK 311	PK 310	0	0	PK 305	PK 304	PK 303	PK 302	PK 301	PK 300	Specifies the grayscale palette.	0																

- Note:
1. “*” means doesn’t matter.
 2. High-speed write mode is available only for the RAM writing.

7. Optical Characteristics

7.1 Optical Characteristics

V_{LCD}=16.8V Ta=25

Item		Symbol	Condition	Min.	Typ.	Max.	Unit
Viewing Angle		x	Cr≥2	y=0 °	-40 -- +35		Deg
		y		x=0 °	-30 -- +30		
Contrast Ratio		Cr	x=0 ° y=0 °	15	-	-	
Response Time	Turn on	Ton	x=0 ° y=0 °	-	-	200	ms
	Turn off	Toff		-	-	200	
Color Of CIE Coord-Inate	Red	Y	x=0 ° y=0 °	-	TBD	-	cd/m ²
		x		-	TBD	-	
		y		-	TBD	-	
	Green	Y	x=0 ° y=0 °	-	TBD	-	cd/m ²
		x		-	TBD	-	
		y		-	TBD	-	
	Blue	Y	x=0 ° y=0 °	-	TBD	-	cd/m ²
		x		-	TBD	-	
		y		-	TBD	-	

7.2 Definition of Optical Characteristics

7.2.1 Definition of Viewing Angle

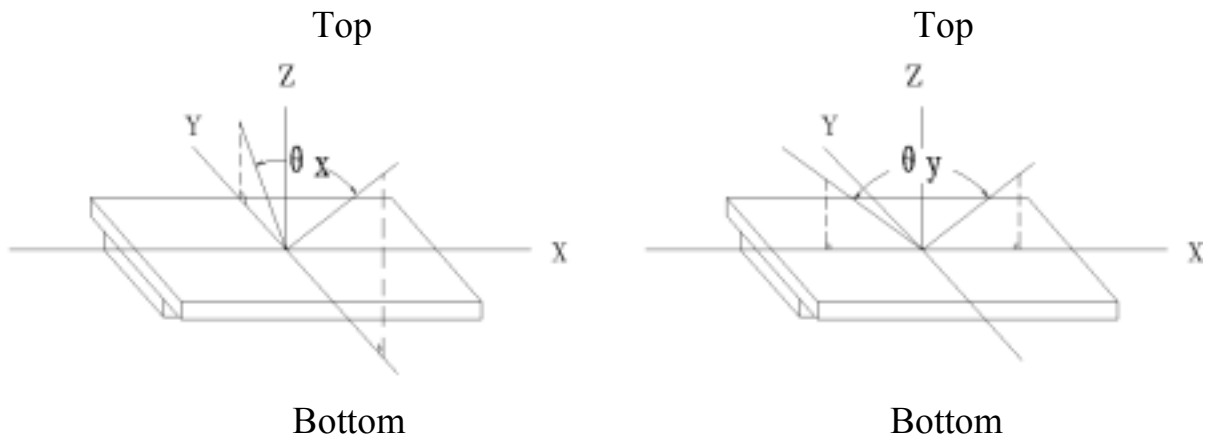

7.2.2 Definition of Contrast Ratio

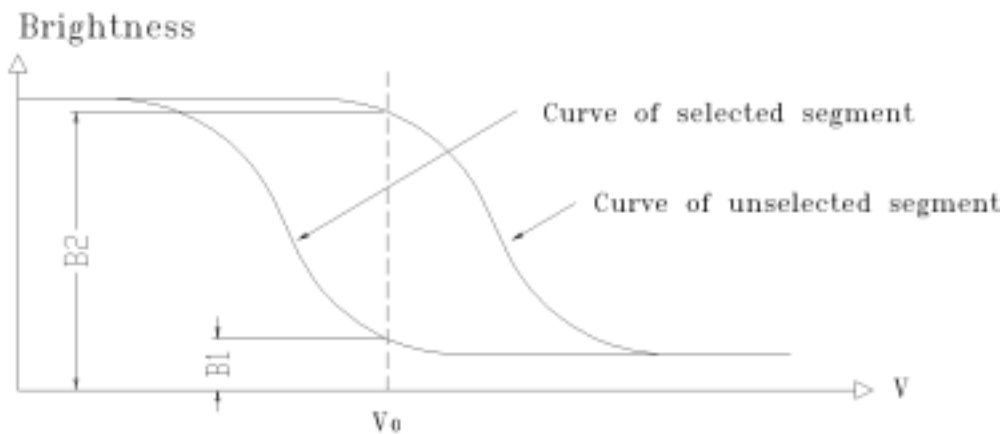

$$\text{Contrast Ratio} = B2/B1 = \frac{\text{unselected state brightness}}{\text{selected state brightness}}$$

Measuring Conditions:

- 1) Ambient Temperature: 25 ; 2) Frame frequency: 70.0Hz

7.2.3 Definition of Response time

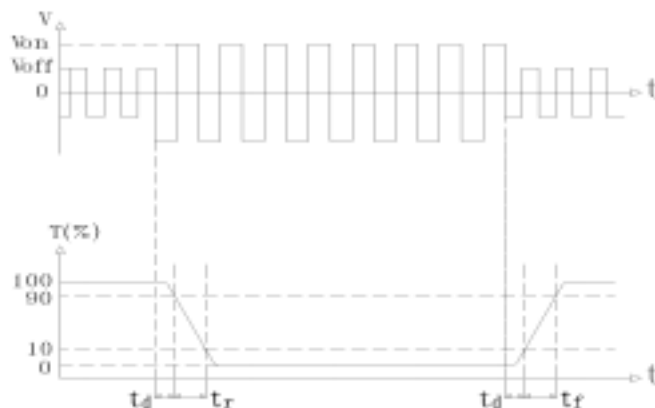

Turn on time: $t_{on} = t_d + t_r$ Turn off time: $t_{off} = t_d + t_f$

Measuring Condition:

- 1) Operating Voltage: 16.8V 2) Frame frequency: 70.0Hz

7.3 Brightness Characteristic

Item	Symbol	Condition	Min.	Typ.	Max.	Unit
Brightness	Bp	Ta=25 ±3	65	-	-	cd/m ²
Uniformity	Bp	30-80%RH	-	-	60	%

Note:

1. The data is measured after CCFLs are turned on for 5 minutes.
2. Testing conditions CCFL: V_{CF} = 270 V (AC)
 LCD: All dots are on (White color)
3. Brightness in the center of the LCD panel.
4. Definition of Uniformity (Bp)
 $Bp = Bp \text{ (Min.)} / Bp \text{ (Max.)} \times 100 \text{ (\%)}$
 Bp (Max.) = Maximum brightness in 9 measurement spots
 Bp (Min.) = Minimum brightness in 9 measurement spots

8. Reliability

8.1 Content of Reliability Test

Ta=25

No.	Test Item	Content of Test	Test condition
1	High Temperature Storage	Endurance test applying the high storage temperature for a long time	80 ±2 240H Restore 4H at 25
2	Low Temperature Storage	Endurance test applying the low storage temperature for a long time	-30 ±2 240H Restore 4H at 25
3	High Temperature /Humidity Storage	Endurance test applying the high temperature and high humidity storage for a long time	70 ±2 90%RH 240H Restore 4H at 25
4	Temperature Cycle	Endurance test applying the low and high temperature cycle -30 25 80 25 30min 5min 30min 5min 1 cycle	-30 /80 10 cycles Restore 4H at 25
5	Vibration Test (package state)	Endurance test applying the vibration during transportation	10Hz~150Hz, 100m/s ² , 120min
6	Shock Test (package state)	Endurance test applying the shock during transportation	Half- sine wave, 300m/s ² , 18ms
7	Atmospheric Pressure Test	Endurance test applying the atmospheric pressure during transportation by air	25kPa 16H Restore 2H

8.2 Failure Judgment Criterion

Criterion Item	Test Item No.									Failure Judgement Criterion
	1	2	3	4	5	6	7	8	9	
Basic Specification	√	√	√	√	√	√	√	√	√	Out of the basic Specification
Electrical specification	√	√	√	√	√					Out of the electrical specification
Mechanical Specification							√	√		Out of the mechanical specification
Optical Characteristic	√	√	√	√	√	√			√	Out of the optical specification
Note	For test item refer to 8.1									
Remark	Basic specification = Optical specification + Mechanical specification									

9. Quality Level

Examination or Test	At $T_a=25$ (unless otherwise stated)	Inspection				
		Min.	Max.	Unit	IL	AQL
External Visual Inspection	Under normal illumination and eyesight condition, the distance between eyes and LCD is 25cm.	See Appendix A			II	Major 1.0 Minor 2.5
Display Defects	Under normal illumination and eyesight condition, display on inspection.	See Appendix B			II	Major 1.0 Minor 2.5
Note: Major defects: Open segment or common, Short, Serious damages, Leakage Miner defects: Others Sampling standard conforms to GB2828						

10. Precautions for Use of LCD Modules

10.1 Handling Precautions

10.1.1 The display panel is made of glass. Do not subject it to a mechanical shock by dropping it from a high place, etc.

10.1.2 If the display panel is damaged and the liquid crystal substance inside it leaks out, be sure not to get any in your mouth, if the substance comes into contact with your skin or clothes, promptly wash it off using soap and water.

10.1.3 Do not apply excessive force to the display surface or the adjoining areas since this may cause the color tone to vary.

10.1.4 The polarizer covering the display surface of the LCD module is soft and easily scratched. Handle this polarizer carefully.

10.1.5 If the display surface is contaminated, breathe on the surface and gently wipe it with a soft dry cloth. If still not completely clear, moisten cloth with one of the following solvents:

- Isopropyl alcohol
- Ethyl alcohol

Solvents other than those mentioned above may damage the polarizer. Especially, do not use the following:

- Water
- Ketone
- Aromatic solvents

10.1.6 Do not attempt to disassemble the LCD Module.

10.1.7 If the logic circuit power is off, do not apply the input signals.

10.1.8 To prevent destruction of the elements by static electricity, be careful to maintain an optimum work environment.

- a. Be sure to ground the body when handling the LCD Modules.
- b. Tools required for assembly, such as soldering irons, must be properly ground.
- c. To reduce the amount of static electricity generated, do not conduct assembly and other work under dry conditions.
- d. The LCD Module is coated with a film to protect the display surface. Be care when peeling off this protective film since static electricity may be generated.

10.2 Storage precautions

10.2.1 When storing the LCD modules, avoid exposure to direct sunlight or to the light of fluorescent lamps.

10.2.2 The LCD modules should be stored under the storage temperature range. If the LCD modules will be stored for a long time, the recommend condition is:

Temperature : 0 ~ 40



Relatively humidity: 80%

10.2.3 The LCD modules should be stored in the room without acid, alkali and harmful gas.

10.3 The LCD modules should be no falling and violent shocking during transportation, and also should avoid excessive press, water, damp and sunshine.

Appendix A

Inspection items and criteria for appearance defects

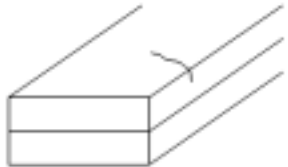
Items	Contents	Criteria		
Leakage		Not permitted		
Rainbow		According to the limit specimen		
Polarizer	Wrong polarizer attachment	Not permitted		
	Bubble between polarizer and glass	Not counted	Max. 3 defects allowed	
		$\phi < 0.3\text{mm}$	0.3mm ϕ 0.5mm	
	Scratches of polarizer	According to the limit specimen		
Black spot (in viewing area)		Not counted	Max. 3 spots allowed	Max. 3 spots (lines) allowed
		$X < 0.2\text{mm}$	0.2mm X 0.5mm	
		$X = (a+b)/2$		
Black line (in viewing area)		Not counted	Max. 3 lines allowed	Max. 3 spots (lines) allowed
		$a < 0.02\text{mm}$	0.02mm a 0.05mm b 2.0mm	
Progressive cracks		Not permitted		

Appendix A

Inspection item and criteria for appearance defects (continued)

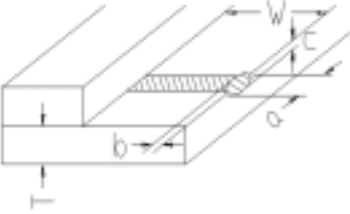
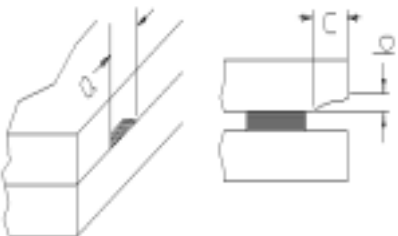
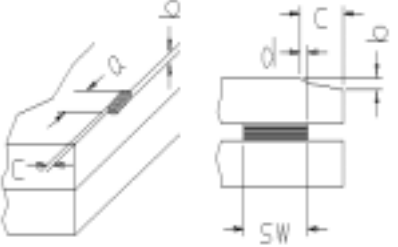
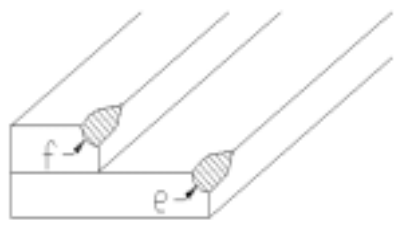
Items	Contents	Criteria							
Glass Cracks	<p>Cracks on pads</p> 	a	b	c	Max. 2 cracks allowed	Max. 5 cracks allowed			
		3mm	W/5	T/2					
		2mm	W/5	$T/2 < C < T$					
	<p>Cracks on contact side</p> 	a	b		Max. 2 cracks allowed				
		3mm	T/2						
		2mm	$T/2 < b < T$						
		C shall be not reach the seal area							
	<p>Cracks on non-contact side</p> 	a	b		Max. 2 cracks allowed				
		3mm	T/2						
		2mm	$T/2 < b < T$						
	C 0.5mm								
	d SW/3								
<p>Corner cracks</p> 	$e < 2.0\text{mm}^2$ $f < 2.0\text{mm}^2$			Max. 3 cracks allowed					

Appendix B

Inspection items and criteria for display defects

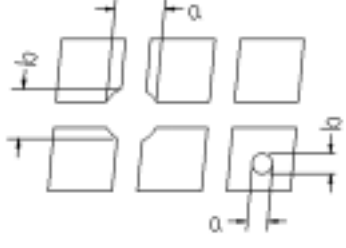
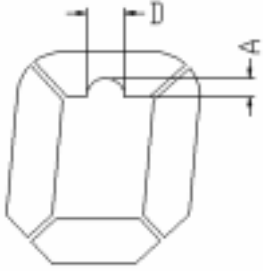
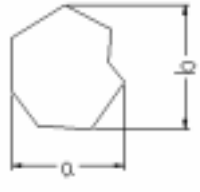
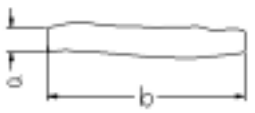
Items	Contents	Criteria			
Open segment or open common		Not permitted			
Short		Not permitted			
Wrong viewing angle		Not permitted			
Contrast ratio uneven		According to the limit specimen			
Crosstalk		According to the limit specimen			
Pin holes and cracks in segment (DOT)		Not counted	Max.3 dots allowed		Max.3 dots allowed
		$X < 0.1\text{mm}$	0.1mm X 0.2mm		
		$X = (a+b)/2$			
		Not counted	Max.2 dots allowed		
$A < 0.1\text{mm}$		0.1mm A 0.2mm $D < 0.25\text{mm}$			
Black spot (in viewing area)		Not counted	Max.3 spots allowed		Max.3 spots (lines) allowed
		$X < 0.1\text{mm}$	0.1mm X 0.2mm		
		$X = (a+b)/2$			
Black line (in viewing area)		Not counted	Max.3 lines allowed		
		$a < 0.02\text{mm}$	0.02mm a 0.05mm b 0.5mm		

Appendix B

Inspection items and criteria for display defects (continued)

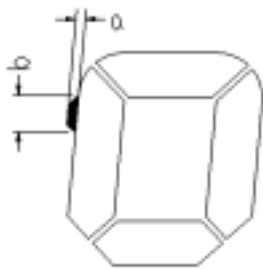
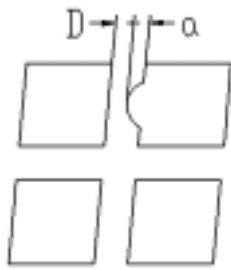
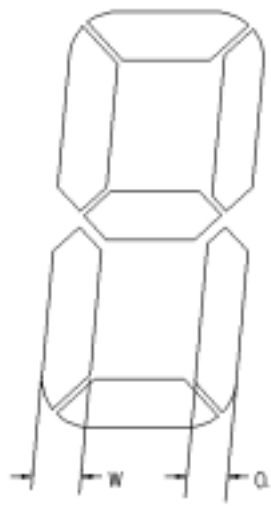
Items	Content	Criteria			
Transformation of segment		Not counted	Max. 2 defects allowed	Max.3 defects allowed	
		$x < 0.1\text{mm}$	0.1mm x 0.2mm		
		$x = (a+b)/2$			
		Not counted	Max. 1 defects allowed		
		$a < 0.1\text{mm}$	0.1mm a 0.2mm $D > 0$		
		Max.2 defects allowed $0.8W \leq a \leq 1.2W$ $a = \text{measured value of width}$ $W = \text{nominal value of width}$			